

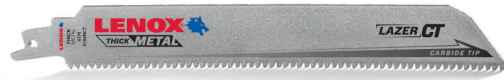

## RECIPROCATING SAW BLADES





## HISTORY OF RECIPI LEADERSHIP

LENOX now has over a century of cutting expertise, delivering solutions that make our tradesmen more productive. LENOX has continued to lead the way with high performance bi-metal blades and is now redefining performance levels with the introduction of the carbide tipped recip platform.

## LENOX RECIPROCATING SAW BLADES

 <p><b>1977</b> Bi-Metal Reciprocating Saw Blades</p>	 <p><b>2008</b> <b>T2</b> Technology up to <b>2X</b> <b>LIFE</b> vs. prior model</p>	 <p><b>2014</b> <b>POWER ARC</b> CURVED BLADE FOR UP TO <b>2X</b> <b>LIFE</b></p>	 <p><b>2016</b> <b>LENOX</b> <b>POWER BLAST</b> TECHNOLOGY Built Stronger Cuts Longer</p>	 <p><b>2016</b> <b>LENOX</b> <b>DEMOLITION CT</b> up to <b>10X</b> <b>LIFE</b></p>	 <p><b>2017</b> <b>LENOX</b> <b>LAZER CT</b> up to <b>10X</b> <b>LIFE</b></p>
---	---	--	---	---	--

### **LAZER CT**<sup>TM</sup> up to **10X****LIFE**\*

LENOX is expanding its performance leadership with the introduction of LENOX LAZER CT<sup>TM</sup> Carbide Tipped reciprocating saw blades for cast iron and stainless steel applications

\*vs. standard LENOX Bi-Metal reciprocating saw blades cutting cast iron and stainless steel.



**NEW**

### **DEMOLITION CT**<sup>TM</sup> up to **10X****LIFE**\*

Upgraded toothforms deliver even longer life in nail-embedded wood applications

\*vs. 6TPI standard LENOX Bi-Metal reciprocating blades cutting wood with nails.



**NEW**

Additional information on these new blades can be found in the following pages.

# LENOX Gold® POWER ARC® RECIPROCATING SAW BLADES

## POWER ARC® CURVED BLADE

Delivers up to 2X longer life vs. standard LENOX straight reciprocating saw blades\*

## AGGRESSIVE BLADE DESIGN

Optimizes the blade's angle of attack for fast cutting in a variety of materials

## EXTENDED BLADE LIFE

T2 Technology™ and precision applied titanium nitride coating help dissipate heat making blades last longer

## FASTER CUTS

Titanium coating makes teeth more wear-resistant so they stay sharp for quicker cuts

\*vs. standard LENOX straight blades.



	TPI	LENGTH X WIDTH X THICKNESS		5-PACK PROD NO	25-PACK PROD NO	APPLICATION
		IN	MM			
EXTREME METAL CUTTING	8	6 x 1 x .042	152 x 25 x 1.07	210926108GR	—	
	8	9 x 1 x .042	229 x 25 x 1.07	210969108GR	—	
	10	6 x 1 x .042	152 x 25 x 1.07	210936110GR	21225B6110GR	
	10	9 x 1 x .042	229 x 25 x 1.07	210979110GR	21229B9110GR	
	10	12 x 1 x .042	305 x 25 x 1.07	2110012110GR	—	
	14	6 x 1 x .035	152 x 25 x .9	210946114GR	21226B6114GR	
	14	9 x 1 x .035	229 x 25 x .9	210989114GR	21235B9114GR	
	14	12 x 1 x .042	305 x 25 x 1.07	2110112114GR	21238B12114GR	
	18	6 x 1 x .035	152 x 25 x .9	210956118GR	21227B6118GR	
18	9 x 1 x .035	229 x 25 x .9	210999118GR	21236B9118GR		
18	12 x 1 x .042	305 x 25 x 1.07	2110212118GR	21239B12118GR		
DEMOLITION	6	6 x 1 x .062	152 x 22 x 1.6	210886066GR*	21220B6066GR*	
	6	9 x 1 x .062	229 x 22 x 1.6	21090966GR	21222B966GR	
	6	12 x 1 x .062	305 x 22 x 1.6	21091106GR	21223B106GR	
	10	9 x 1 x .062	229 x 22 x 1.6	21089960GR	21221B960GR	
METAL	10	6 x 3/4 x .035	152 x 19 x .9	21064610GR	21078B610GR	
	10	8 x 3/4 x .050	203 x 19 x 1.3	21065810GR	21079B810GR	
	14	4 x 3/4 x .035	102 x 19 x .9	21066414GR*	21080B414GR*	
	14	6 x 3/4 x .035	152 x 19 x .9	21067614GR	21081B614GR	
	18	4 x 3/4 x .035	102 x 19 x .9	21068418GR*	—	
	18	6 x 3/4 x .035	152 x 19 x .9	21069618GR	21083B618GR	
	18	8 x 3/4 x .035	203 x 19 x .9	21070818GR	21084B818GR	
	24	4 x 3/4 x .035	102 x 19 x .9	21071424GR*	—	
	24	6 x 3/4 x .035	152 x 19 x .9	21072624GR	21086B624GR	
24	8 x 3/4 x .035	203 x 19 x .9	21073824GR	21087B824GR		
WOOD	6	6 x 7/16 x .050	152 x 11 x 1.3	21063676GRC*	—	
	6	6 x 3/4 x .050	152 x 19 x 1.3	21060656GR	21074B656GR	
	6	9 x 3/4 x .050	229 x 19 x 1.3	21062956GR	21076B956GR	
	6	12 x 3/4 x .050	305 x 19 x 1.3	21061156GR	21075B156GR	

\*Blades do not feature POWER ARC® technology.



## DEMOLITION CT™ RECIPROCATING SAW BLADES

**Carbide Tipped for the Highest Performance  
in Nail-Embedded Wood**

### UP TO 10X LONGER LIFE THAN BI-METAL RECIPROCATING BLADES\*

High performance carbides are welded to increase durability and prevent tooth loss

### INCREASED DURABILITY

Thick blade profile provides increased durability and control in tough demolition applications

### ENGINEERED FOR FAST PERFORMANCE

Each tooth is precision ground to cut through nails with ease

\*vs. 6TPI standard LENOX Bi-Metal reciprocating blades cutting wood with nails.



TPI	LENGTH X WIDTH X THICKNESS		1-PACK PROD NO	5-PACK PROD NO	APPLICATION
	IN	MM			
6	6 x 1 x .050	152 x 22 x 1.3	1832118	1832162	
6	9 x 1 x .050	229 x 22 x 1.3	1832143	1832144	
6	12 x 1 x .050	305 x 22 x 1.3	1832146	1832147	

## DEMOLITION RECIPROCATING SAW BLADES

**Best Bi-Metal Blade for Demolition Applications**



### POWER BLAST TECHNOLOGY® INCREASES BLADE LIFE

High speed blasting along the cutting edge strengthens the blade to reduce breaks and increase durability

### INCREASED DURABILITY

Tall and thick blade profile helps prevent bending during cutting and provides increased control in tough demolition applications



TPI	LENGTH X WIDTH X THICKNESS		2-PACK PROD NO	5-PACK PROD NO	10-PACK PROD NO	25-PACK PROD NO	50-PACK PROD NO	APPLICATION
	IN	MM						
6	6 x 1 x .062	152 x 22 x 1.6	205126066R	203706066R5	1861832	20514B6066R	—	
6	9 x 1 x .062	229 x 22 x 1.6	20598966R	20371966R5	1861605	20523B966R	227630SB966R	
6	12 x 1 x .062	305 x 22 x 1.6	20500106R	20373106R5	1861939	20485B106R	—	
10	9 x 1 x .062	229 x 22 x 1.6	20597960R	20372960R5	1861833	20524B960R	227620SB960R	

## LAZER CT™ RECIPROCATING SAW BLADES

### Carbide Tipped for the Highest Performance in Cast Iron and Stainless Steel

#### UP TO 10X LONGER LIFE THAN BI-METAL RECIPROCATING BLADES\*

High performance carbides are welded to increase durability and prevent tooth loss

#### STRAIGHT CUTS IN LARGE DIAMETER MATERIALS

Tall blade profile delivers straight cuts and long life in demanding metal cutting applications

#### ENGINEERED FOR FAST PERFORMANCE

Each tooth is precision ground to quickly cut through difficult metals

\*vs. standard LENOX Bi-Metal reciprocating saw blades cutting cast iron and stainless steel.



TPI	LENGTH X WIDTH X THICKNESS		1-PACK PROD NO	5-PACK PROD NO	APPLICATION
	IN	MM			
8	4 x 1 x .052	102 x 25 x 1.3	2014212	2014214	All metals greater than 3/16" 
8	6 x 1 x .052	152 x 25 x 1.3	2014220	2014223	
8	9 x 1 x .052	229 x 25 x 1.3	2014224	2014225	

## LAZER™ RECIPROCATING SAW BLADES

### Best Bi-Metal Blade for Heavy Metal Cutting

#### POWER BLAST TECHNOLOGY™ INCREASES BLADE LIFE

High speed blasting along the cutting edge strengthens the blade to reduce breaks and increase durability

#### STRAIGHT CUTS IN LARGE DIAMETER MATERIALS

Tall blade profile delivers straight cuts and long life in demanding metal cutting applications

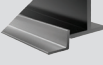

TPI	LENGTH X WIDTH X THICKNESS		2-PACK PROD NO	5-PACK PROD NO	10-PACK PROD NO	25-PACK PROD NO	50-PACK PROD NO	APPLICATION
	IN	MM						
8	6 x 1 x .042	152 x 25 x 1.07	—	201926108R	—	—	—	Structural Steels greater than 3/16" 
8	9 x 1 x .042	229 x 25 x 1.07	—	201939108R	—	20195B9108R	—	
8	12 x 1 x .042	305 x 25 x 1.07	—	2019412108R	—	—	—	
10	6 x 1 x .042	152 x 25 x 1.07	24901T6110R	201706110R	—	20171B6110R	—	Structural Steels and All Metals 3/16"–1/2" 
10	9 x 1 x .042	229 x 25 x 1.07	24905T9110R	201769110R	1861951	20177B9110R	—	
10	12 x 1 x .042	305 x 25 x 1.07	—	2018212110R	—	20183B12110R	—	
14	6 x 1 x .035	152 x 25 x .9	24902T6114R	201726114R	—	20173B6114R	227640SB6114R	Structural Steels and All Metals 3/32"–3/8" 
14	9 x 1 x .035	229 x 25 x .9	24906T9114R	201789114R	1861952	20179B9114R	227660SB9114R	
14	12 x 1 x .042	305 x 25 x 1.07	24910T12114R	2018412114R	—	20185B12114R	—	
18	6 x 1 x .035	152 x 25 x .9	24903T6118R	201746118R	1861940	20175B6118R	227650SB6118R	Structural Steels and All Metals 1/16"–1/4" 
18	9 x 1 x .035	229 x 25 x .9	24907T9118R	201809118R	1861953	20181B9118R	227670SB9118R	
18	12 x 1 x .042	305 x 25 x 1.07	24911T12118R	2019012118R	—	20191B12118R	—	



# BI-METAL RECIPROCATING SAW BLADES

**Built Stronger. Cuts Longer.**

## POWER BLAST TECHNOLOGY™ INCREASES BLADE LIFE

High speed blasting along the cutting edge strengthens the blade to reduce breaks and increase durability

## LONG BLADE LIFE & INCREASED VERSATILITY

Patented T2 Technology™ reduces cutting forces on each tooth and optimizes chip removal to allow efficient cutting in a wide range of materials



	TPI	LENGTH X WIDTH X THICKNESS		1-PACK PROD NO	5-PACK PROD NO	10-PACK PROD NO	25-PACK PROD NO	50-PACK PROD NO	APPLICATION
		IN	MM						
WOOD CUTTING	4	6 x 3/4 x .050	152 x 19 x 1.3	20574S634R**	20575634R**	—	—	—	
	6	4 x 3/4 x .050	102 x 19 x 1.3	—	20449456RP**	—	—	—	
	6	6 x 3/4 x .050	152 x 19 x 1.3	20571S636RP**	20570636RP**	—	20497B636RP**	—	
	6	6 x 3/4 x .035	152 x 19 x .9	20559S606R	20560606R	—	20492B606R	—	
	6	6 x 7/16 x .050	152 x 11 x 1.3	20557S676RC**	20556676RC**	—	—	—	
	6	6 x 3/4 x .050	152 x 19 x 1.3	20573S656R	20572656R	1861220	20530B656R	227500SB656R	
	6	9 x 3/4 x .050	229 x 19 x 1.3	20587S956R	20582956R	1861354	20558B956R	227520SB956R	
	6	12 x 3/4 x .050	305 x 19 x 1.3	20586S156R	20585156R	1861769	20495B156R	227550SB156R	
GENERAL PURPOSE	10	6 x 3/4 x .035	152 x 19 x .9	20561S610R	20562610R	—	20493B610R	227610SB610R	
	10	8 x 3/4 x .050	203 x 19 x 1.3	20581S810R	20580810R	1861352	20590B810R	227530SB810R	
	10/14	6 x 3/4 x .050	152 x 19 x 1.3	20592650R*	20374650R5	—	20515B650R	—	
	10/14	8 x 3/4 x .050	203 x 19 x 1.3	—	20577850R	—	20535B850R	—	
	10/14	12 x 3/4 x .050	305 x 19 x 1.3	20584S110R	20583110R	—	20491B110R	227580SB110R	
	10/14	6 x 3/4 x .035	152 x 19 x .9	—	12129635R	—	—	—	
	10/14	8 x 3/4 x .035	203 x 19 x .9	—	12130835R	—	—	—	
THICK METAL	14	3-5/8 x 5/16 x .035	92 x 8 x .9	—	20520314RC	—	—	—	
	14	4 x 3/4 x .035	102 x 19 x .9	—	20550414R	—	20488B414R	227600SB414R	
	14	6 x 3/4 x .035	152 x 19 x .9	20565S614R	20564614R	1861216	20494B614R	227560SB614R	
	14	8 x 3/4 x .035	203 x 19 x .9	—	21519814R	—	1855567	1855570	
	14	9 x 3/4 x .050	225 x 19 x 1.3	205119514R*	—	—	—	—	
MEDIUM METAL	18	3-5/8 x 5/16 x .035	92 x 8 x .9	20522S318RC	20521318RC	—	—	—	
	18	4 x 3/4 x .035	102 x 19 x .9	20553S418R	20552418R	—	20489B418R	227590SB418R	
	18	6 x 3/4 x .035	152 x 19 x .9	20567S618R	20566618R	1861217	20529B618R	227510SB618R	
	18	8 x 3/4 x .035	203 x 19 x .9	20563S818R	20578818R	1861353	20487B818R	227540SB818R	
	18	12 x 3/4 x .035	305 x 29 x .9	—	21510118R	—	21511B118R	—	
THIN METAL	24	4 x 3/4 x .035	102 x 19 x .9	—	20554424R	—	20490B424R	—	
	24	6 x 3/4 x .035	152 x 19 x .9	20569S624R	20568624R	1861218	20496B624R	227570SB624R	
	24	8 x 3/4 x .035	203 x 19 x .9	—	20579824R	—	—	—	

\*This item is a 2-pack. \*\*Blades do not feature T2 Technology™.

# LENOX DIAMOND™ RECIPROCATING SAW BLADES

## Cuts Cast. Fast.

### LASTS LONGER

Nickel alloy-brazed diamond particles maintain sharpness to keep cutting after conventional carbide grit blades fail

### CUTS 3X FASTER\*

A narrow kerf design enables thinner, faster cuts

### STRAIGHT, CLEAN CUTS

Unlike bulky snap cutters which crush pipes and leave ragged, uneven cuts, LENOX DIAMOND cuts clean. Durable chrome alloy backing steel provides extra stability

\*Speed measured cutting 4" cast iron pipe at maximum speed vs. the leading competitor.



LENGTH X WIDTH X THICKNESS		1-PACK	APPLICATION
IN	MM	PROD NO	
8 x 3/4 x .040	203 x 19 x 1	10833800RDG	Cast Iron, Tile, Brick and Natural Stone
9 x 3/4 x .042	225 x 19 x 1.07	1766338*	
11 x 3/4 x .042	275 x 19 x 1.07	1766356*	

\*Double Tang.



# CARBIDE GRIT RECIPROCATING SAW BLADES

## For Cutting Non-Metallic Materials

### HIGH PERFORMANCE IN ABRASIVE MATERIALS

Cuts through tough materials that resist chip-forming, including ceramics, pipe, man-made stone, brick, marble and more

### SMOOTH, QUICK CUTS

Uniformly applied, durable carbide grit particles on a flexible blade provide fast cuts without snagging or binding



LENGTH X WIDTH X THICKNESS		2-PACK	GRIT	APPLICATION
IN	MM	PROD NO		
6 x 3/4 x .032	152 x 19 x .8	20505600RG	Medium	Fiberglass, Ceramic Tile, Cultured Marble, Clays, Brick
8 x 3/4 x .040	203 x 19 x 1	20576800RG	Medium	
10 x 3/4 x .050	254 x 19 x 1.3	20506100RG	Medium	

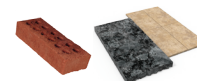

# EXTRA SHARP FLEAM GROUND RECIPROCATING SAW BLADES

## Fast, Clean Cutting in Wood or Plastic

### BI-METAL CONSTRUCTION

Durable and flexible to survive nail strikes

### FLEAM GROUND TOOTH FORM

Fast, clean wood cutting

### IDEAL FOR CLEAN WOOD, PLASTIC PIPE AND TREE PRUNING



TPI	LENGTH X WIDTH X THICKNESS		5-PACK	APPLICATION
	IN	MM	PROD NO	
6	6 x 3/4 x .050	152 x 19 x 1.3	121016W6R	Clean Wood, Plastics, Pruning
6	9 x 3/4 x .050	229 x 19 x 1.3	121029W6R	

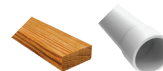

## RECIPROCATING SAW BLADE KITS



**121439KPE**  
**9 PIECE**  
**GENERAL PURPOSE KIT**  
Includes Storage Case

QTY	PROD NO	TPI	LENGTH X WIDTH X THICKNESS	
			IN	MM
2	656R	6	6 x 3/4 x .050	152 x 19 x 1.3
2	624R	24	6 x 3/4 x .035	152 x 19 x .9
2	818R	18	8 x 3/4 x .035	203 x 19 x .9
2	810R	10	8 x 3/4 x .050	203 x 19 x 1.3
1	960R	10	9 x 7/8 x .062	229 x 22 x 1.6



**121442RKD**  
**12 PIECE**  
**DEMOLITION KIT**  
Includes Storage Case

QTY	PROD NO	TPI	LENGTH X WIDTH X THICKNESS	
			IN	MM
3	6066R	6	6 x 7/8 x .062	150 x 22 x 1.6
3	6114R	14	6 x 1 x .035	150 x 25 x .9
2	9114R	14	9 x 1 x .035	229 x 25 x .9
2	966R	6	9 x 7/8 x .062	229 x 22 x 1.6
2	960R	10	9 x 7/8 x .062	229 x 22 x 1.6



**20502546A**  
**5 PIECE**  
**GENERAL PURPOSE KIT**  
4" and 6" Blade Assortment

QTY	PROD NO	TPI	LENGTH X WIDTH X THICKNESS	
			IN	MM
1	414R	14	4 x 3/4 x .035	102 x 19 x .9
1	418R	18	4 x 3/4 x .035	102 x 19 x .9
1	614R	14	6 x 3/4 x .035	152 x 19 x .9
1	618R	18	6 x 3/4 x .035	152 x 19 x .9
1	656R	6	6 x 3/4 x .050	152 x 19 x 1.3



**1839466**  
**5 PIECE**  
**METAL CUTTING KIT**

QTY	PROD NO	TPI	LENGTH X WIDTH X THICKNESS	
			IN	MM
3	618R	18	6 x 3/4 x .035	152 x 19 x .9
2	818R	18	8 x 3/4 x .035	203 x 19 x .9



**1839467**  
**5 PIECE**  
**WOOD CUTTING KIT**

QTY	PROD NO	TPI	LENGTH X WIDTH X THICKNESS	
			IN	MM
3	656R	6	6 x 3/4 x .050	152 x 19 x 1.3
2	956R	6	9 x 3/4 x .050	229 x 19 x 1.3



**1839465**  
**5 PIECE**  
**DEMOLITION KIT**

QTY	PROD NO	TPI	LENGTH X WIDTH X THICKNESS	
			IN	MM
1	6066R	6	6 x 1 x .062	150 x 25 x 1.6
1	6114R	14	6 x 1 x .035	150 x 25 x .9
1	9114R	14	9 x 1 x .035	229 x 25 x .9
1	966R	6	9 x 1 x .062	229 x 25 x 1.6
1	960R	10	9 x 1 x .062	229 x 25 x 1.6



**1073415RKG**  
**15 PIECE**  
**GENERAL PURPOSE KIT**  
Includes Storage Case

QTY	PROD NO	TPI	LENGTH X WIDTH X THICKNESS	
			IN	MM
5	614R	14	6 x 3/4 x .035	152 x 19 x .9
5	618R	18	6 x 3/4 x .035	152 x 19 x .9
5	656R	6	6 x 3/4 x .050	152 x 19 x 1.3



# RECIPROCATING SAW BLADE SELECTION GUIDE

	WOOD	NAIL-EMBEDDED WOOD	DRYWALL/PLASTER	NON-FERROUS METAL	DEMOLITION	FIRE & RESCUE	PLASTICS & COMPOSITES	THIN METAL	MEDIUM METAL	THICK METAL	STAINLESS STEEL	CAST IRON	TILE & GRANITE	ABRASIVES
<b>BEST</b>	DEMOLITION CT™	BI-METAL	LENOX Gold® POWER ARC®						LAZER CT™		LENOX DIAMOND™			
<b>BETTER</b>	LENOX Gold® POWER ARC®	—	LAZER™	BI-METAL		LAZER™		LENOX Gold® POWER ARC®	LENOX DIAMOND™	CARBIDE GRIT				
<b>GOOD</b>	BI-METAL	—	BI-METAL	—		BI-METAL		LAZER™	CARBIDE GRIT	—				

## TEETH PER INCH SELECTION GUIDE

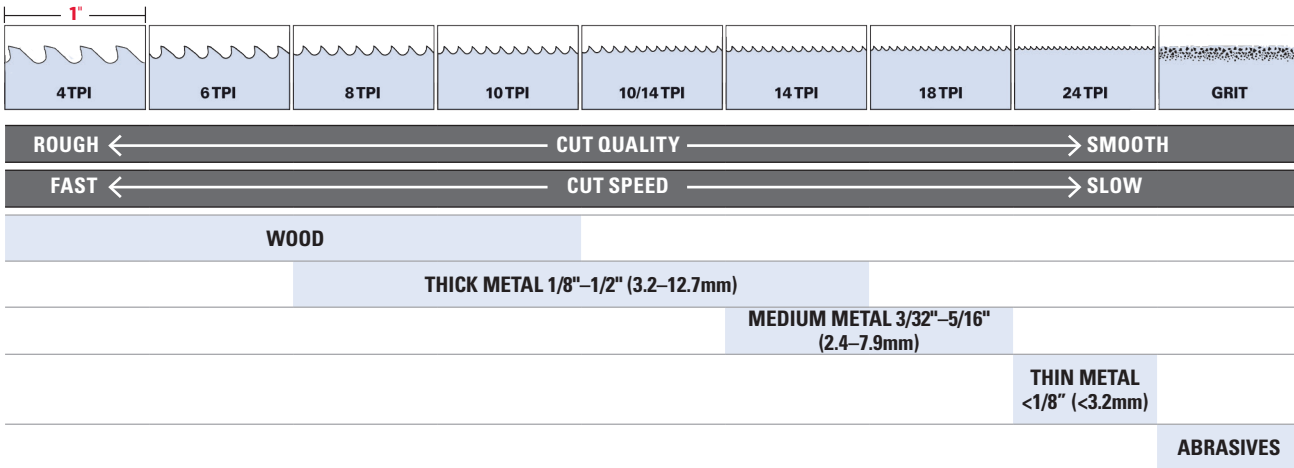

## BLADE LENGTH SELECTION GUIDE

**TIP** Always keep 2-3 teeth in the material at all times

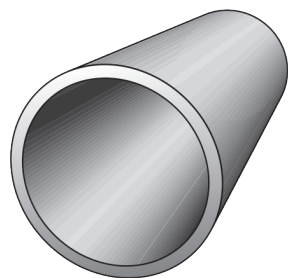

← WIDTH →

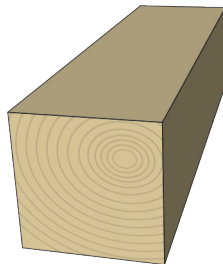

← WIDTH →

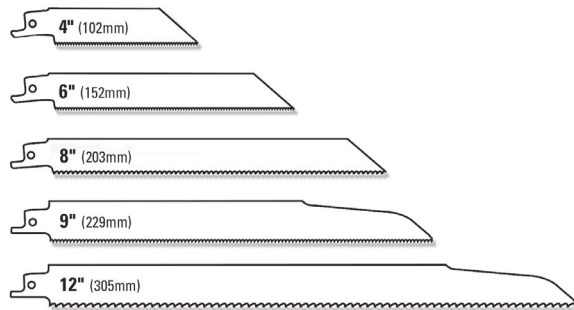













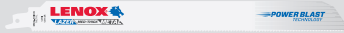

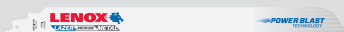

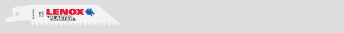





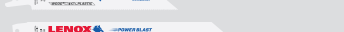

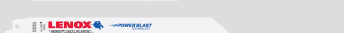
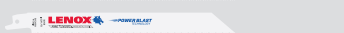
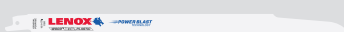
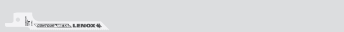
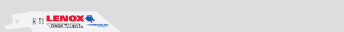
WIDTH OF MATERIAL + 3" (76mm) = BLADE LENGTH  
 EXAMPLE: 5" (WIDTH) + 3" (76mm) = 8" (203mm).  
 USE AN 8" (203mm) OR 9" (229mm) BLADE

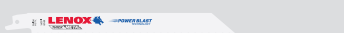
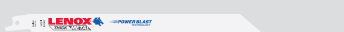
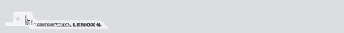
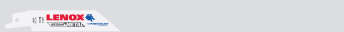

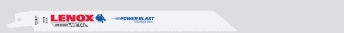
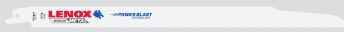
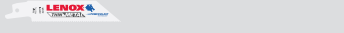
# RECIPROCATING SAW BLADES CROSS REFERENCE CHART

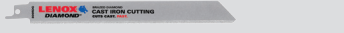
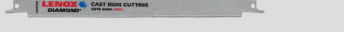
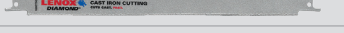
	TPI	LENGTH		DESC	SHAPE	MILWAUKEE®	DIABLO®	M.K. MORSE
		IN	MM					
<b>LENOX Gold® POWER ARC®</b>	6	6	152	676GRC*		—	—	—
	6	6	152	656GR		—	—	—
	6	6	152	6066GR*		—	—	—
	6	9	229	956GR		—	—	—
	6	9	229	966GR		—	—	—
	6	12	305	156GR		—	—	—
	6	12	305	106GR		—	—	—
	8	6	152	6108GR		—	—	—
	8	9	229	9108GR		—	—	—
	10	6	152	610GR		—	—	—
	10	6	152	6110GR		—	—	—
	10	8	203	810GR		—	—	—
	10	9	229	9110GR		—	—	—
	10	9	229	960GR		—	—	—
	10	12	305	12110GR		—	—	—
	14	4	102	414GR*		—	—	—
	14	6	152	614GR		—	—	—
	14	6	152	6114GR		—	—	—
	14	9	229	9114GR		—	—	—
	14	12	305	12114GR		—	—	—
	18	4	102	418GR*		—	—	—
	18	6	152	618GR		—	—	—
	18	6	152	6118GR		—	—	—
	18	8	203	818GR		—	—	—
18	9	229	9118GR		—	—	—	
18	12	305	12118GR		—	—	—	
24	4	102	424GR*		—	—	—	
24	6	152	624GR		—	—	—	
24	8	203	824GR		—	—	—	
<b>LAZER CT™</b>	8	4	102	4108RCT		—	DS0408CF, DS0408CF3	—
	8	6	152	6108RCT		—	DS0608CF, DS0608CF3	—
	8	9	229	9108RCT		—	DS0908CF, DS0908CF3	—
<b>DEMOLITION CT™</b>	6	6	152	656RCT		5221	DS0606CWS, DS0606CWS3	—
	6	9	229	956RCT		5226	DS0906CWS, DS0906CWS3	—
	6	12	305	156RCT		5227	DS1206CWS, DS1206CWS3	—
<b>DEMOLITION</b>	6	6	152	6066R		5021, 8021	DS0614BGP5	—
	6	9	229	966R		5026	—	—
	6	12	305	106R		5027	—	—
	10	9	229	960R		—	—	RBR962811T03, RB96210T03
<b>LAZER™</b>	8	6	152	6108R		2701, 5701, 8701	—	RBAE6811T05, RBAE650811T05
	8	9	229	9108R		5706, 8706	—	RBAE9811T05, RBAE950811T05
	8	12	305	12108R		5711	—	RBAE12811T05, RBAE1250811T05
	10	6	152	6110R		4172, 5712	DS0608BFD5, DS0608CF3	—
	10	9	229	9110R		4713, 5713	DS0908BFD2, DS0908BFD5, DS0908BFD25	RB1010T05
	10	12	305	12110R		5714	—	RBSA121014T05, RB1210T05

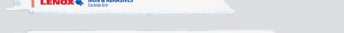
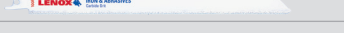
\*Blades do not feature POWER ARC® technology.

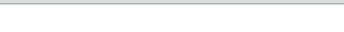
	TPI	LENGTH		DESC	SHAPE	MILWAUKEE®	DIABLO®	M.K. MORSE
		IN	MM					
<b>LAZER™</b>	14	6	152	6114R		4782	DS0414BF5, DS0614BF2, DS0614BF5, DS0614BF25	RBPB65014T05, RBAE61115T05, RBAE6501115T05
	14	9	229	9114R		4787, 5787	DS0914BF5	RBPB125014T05, RBAE91115T05, RBAE9501115T05
	14	12	305	12114R		5794	DS1214BF5	RBAE12115T05, RBAE1250115T05, RBPB125014T05
	18	6	152	6118R		4784, 5784	—	RB65018T05, RBAE61521T05, RBAE6501521T05
	18	9	229	9118R		4788, 5790, 5788	—	RBSA818T05, RBAE91521T05, RBAE9501521T05
	18	12	305	12118R		4789, 5791, 8789, 5789	—	RBSA1218T05, RBAE121521T05, RBAE12501521T05
<b>STANDARD BI-METAL</b>	4	6	152	634R		—	—	—
	6	4	102	456RP		5052	—	—
	6	6	152	636RP		—	—	RB65006PT05
	6	6	152	656R		5035	DS0612BW2, DS0612BW5, DS0612BW25	RB63506T05, RB65006T05, RB65058T05
	6	6	152	676RC		1606, 5041	—	RB65006CT05, RB65006CT50
	6	6	152	606R		5015	—	—
	6	9	229	956R		5016, 5036	DS0912BW2, DS0912BW5, DS0912BW25	RB95006C2, RB93506T05, RB95006T05
	6	12	305	156R		5017, 5037	DS1212BW2, DS1212BW5, DS1212BW25	RB123506T05, RB125006T05
	10	6	152	610R		5090, 5091, 4091, 5092	—	RBWP64210T05, RB610T05
	10	8	203	810R		4093, 5093	DS0914BGP2, DS0914BGP5, DS0914BGP25	RBWP94210T05, RB810T05
	10/14	6	152	635R		—	—	—
	10/14	6	152	650R		—	—	RB41014T05, RB61014T05, RB6501014T05, RB6501014TT05
	10/14	8	203	835R		5193	—	—
	10/14	8	203	850R		5193	DS0914AFC2, DS0914AFC5	RB81014C2, RB850812T05, RB81014T05, RB8501014T05
	10/14	12	305	110R		5094, 5194	DS1214AFC5	RB125010T05, RB12551014T05, RB121014T05, RB12501014STT05
	14	3-5/8	92	314RC		5161, 5162	—	—
	14	4	102	414R		5181	—	RB414T05
	14	6	152	614R		5182, 4182,	—	RB65014T05, RB64214T05, RBWP64214T05, RB614T05
	14	8	203	814R		5187, 4182, 7187	—	RB814, RBMC814
	14	9	225	9514R		—	—	RBWP94214T05
	18	3-5/8	92	318RC		5163	—	RB318ST05, RB318ST50
	18	4	102	418R		5183	—	—
	18	6	152	618R		4184, 5184	—	RB64218T05, RB618T05, RBWP64218T05
	18	8	203	818R		4188, 5188	—	RB94218T05, RB918T05, RB818T05
	18	12	305	118R		5189	—	RB124218T05, RB1018T05, RB1218T05
	24	4	102	424R		5185	—	RB424T05
24	6	152	624R		4186, 5186, 8186	—	RB64224T05, RB624T05	
24	8	203	824R		—	DS0920BF2, DS0920BF5, DS0920BF25	—	
<b>LENOX DIAMOND™</b>	Grit	8	203	800DRDG		1440	DS0930CGX	RBDG6C
	Grit	9	225	800DTDG		1450	DS0930DGX	RBDG9C
	Grit	11	275	100DTDG		—	—	—
<b>CARBIDE GRIT</b>	Grit	6	152	600RG		1421, 6430, 1420	—	RTC66
	Grit	8	203	800RG		1431, 6430, 1430	—	RTC68
	Grit	10	254	100RG		—	—	—
<b>FLEAM GROUND</b>	6	6	152	6W6R		1301, 1303, 1304, 1305, 7015, 7016	—	—
	6	9	229	9W6R		—	DS0905FG, DS0905FG5, DS1205FG, DS1205FG5	—

Milwaukee® is a registered trademark of Milwaukee Electric Tool Corp.  
Diablo® is a registered trademark of Freud America, Inc.



618R

**LENOX**  
MEDIUM METAL



**POWER BLAST**  
TECHNOLOGY

 [facebook.com/lenoxtools](https://facebook.com/lenoxtools)

 [youtube.com/lenoxtools](https://youtube.com/lenoxtools)

Customer Service: 800-628-8810  
Technical Support: 800-642-0010  
[lenoxtools.com](https://lenoxtools.com)

©2017 LENOX  
LENX1027